

Uniden[®]

**DECT1725
DECT1725+1
DECT1725+2**

Series Owners Manual

OWNER'S MANUAL



Welcome...

Introducing your Digital Cordless Telephone

- Caller ID* to see who's calling before you pick up the phone
- 40 Number Calls log
- 50 Names and numbers phonebook
- 10 Last number redial
- 10 Handset ringer melodies to choose from.

* Feature requires Caller ID service from network supplier. There is usually a fee for this service.

In this guide you will find all the information you need, explained simply to help you get the most from your phone.



What's in the box:

- Handset
- Base
- 2 x NiMH rechargeable batteries AAA size (1.2V 550 mAh)
- Power supply
- Telephone line cord
- Charger (multi-packs only)

For each additional handset, you will have the following:

- Additional handset
- Charger with power supply attached
- 2 x NiMH rechargeable batteries AAA size (1.2V 550 mAh)

IMPORTANT

This equipment is not designed for making emergency calls when the power fails. Alternative arrangements should be made for access to emergency services.



Contents

Setting up	4	Redial the last number called	14
Finding a location	4	Redial any of the last 10 numbers called	14
Connecting your phone	4	Store a redial number to the phonebook	14
Preparing the handsets	5	Deleting numbers from the redial list	15
Installing and charging the handset batteries	5	Mute (privacy)	15
Battery Low Warning	5	Finding/paging handsets	15
Battery Performance	5	Keypad lock	16
Setting the date and time	6	Using the phonebook	17
Connecting the telephone line cord	6	Store a phonebook name/number	17
Your handset	7	View and dial a phonebook entry	18
Your DECT1725 base and charger (+1, +2 models only)	8	Edit a phonebook name/number	18
Your handset display	9	Delete a phonebook name/number	19
Standby Display	10	Phonebook status	19
Quick Guide	11	Handset and base menu settings	20
Using your phone	12	Handset earpiece	20
Make a call	12	Handset ringer volume	20
Adjust the earpiece/receiver volume during a call	12	Handset speaker	20
Preparatory dialling (pre-dial)	12	Handset ringer type	21
Handset range	12	Auto answer	21
Call timer	12	Alarm	22
Handsfree mode	13	Handset name	22
End a call	13	Language	23
Receive a call	13	Base ringer volume	23
Call Waiting	13	Base ringer type	24
Receiving internal calls	13	Call barring	25
Redial	14		

Settings menu	26
Tones	26
Flash	26
Dial Mode	27
Tone Dialling Switch-Over (Australia only)	27
Registering a new handset	27
De-register a handset	28
Base PIN code	29
Selecting a base	29
Resetting your phone	30
Default settings	31
Network services	32
Caller ID	32
Calls log	32
View the Calls log	33
Dial calls log number	33
Copy Calls log number to the phonebook	33
Delete Calls log entry(ies)	34
Using extra handsets	35
Register your handset to another base	35
Call another handset (internal call)	35
Answer an external call while on an internal call	35
Transferring a call	36
Conference call	36
Simple solutions	37

Handset/Base	37
Caller ID	38
General information	39
Safety	39
Maintenance	40
Cleaning your product	40
Replacing the handset batteries	40
How many telephones can I have?	41
Warranty	42



Setting up

Follow these simple steps to prepare your phone(s) ready for use.

Finding a location

Make sure your phone is:

- Within 1.8 metres of a power and phone socket so that the cords will reach.
- At least 1 metre away from other electrical appliances, to avoid interference.
- Not located in humid or damp conditions, e.g. in a bathroom.



Connecting your phone

- 1 Connect the base power supply into the socket on the back of the base. Plug the other end into the mains power socket.

WARNING

Use only the power supply that came with your phone.

Using another power supply could seriously damage your phone and invalidate your warranty.

Do not connect the telephone line cord until your handset is fully charged. This will prevent the risk of the phone being answered before the batteries are charged. Answering the phone before the batteries are fully charged may prevent them from reaching their optimum capacity.

- 2 *On each charger (multi-packs only):*

Connect the power supply attached to each charger into the mains and switch on.





Preparing the handsets

Installing and charging the handset batteries.

- 1 *On each handset:*
Remove the battery compartment cover.
Press down on the semi-circle indent and slide the cover off.
Connect the supplied batteries with the correct polarity.
Slide the battery cover back until it clicks securely into place.
- 2 To charge the batteries, place the handset(s) on the base or on a charger. The charging light in the base illuminates. The  symbol scrolls until the handset is fully charged.
If the charging light does not come on, reposition the handset in the base or charger, ensuring that the charging points contact. You must charge each handset for 15-20 hours before use.

WARNING

Under no circumstances should non-rechargeable batteries be used. Only use the supplied battery pack or you will invalidate your guarantee and may damage the telephone.



BATTERY LOW WARNING

If the  symbol is displayed on the handset or if you hear the low battery tone, you will need to recharge your handset.

Note: If you set the "Battery Low" tone to off, the low battery tone will not sound.

We recommend that you place the handset back on the base/charger between use to ensure that it is always fully charged.

Battery Performance

The handset may become warm during charging, this is normal. On a single charge your handset will give 10 hours talk time and 7 days standby time.

New NiMH batteries do not reach their full capacity until they have been in use for several days.

Over time, as the batteries wear out, the charge capacity will reduce, so reducing the talk/standby time of the handset.























Eventually the batteries will need to be replaced.



Setting the date and time

The phone uses the 12 or 24 hour clock.

In standby mode:

- 1 Press .
- 2 Press  or  to select HS SETTINGS and press .
- 3 Press  or  to select DATE & TIME and press .
- 4 Press  or  to select DATE FORMAT and press .
- 5 Press  or  to select MM - DD or DD - MM and press .
- 6 Press  or  until TIME FORMAT is displayed and press .
- 7 Press  or  to select 24 - HOUR or 12 - HOUR and press .
- 8 Press  or  until SET TIME is displayed and press .
- 9 Enter Hour and Minute using the keypad, and press .

Connecting the telephone line cord

High Speed Internet

If your phone line also has High Speed Internet please ensure you are using an approved line filter before connecting the telephone cord.

- 1 Connect the telephone line cord into the **TEL LINE** socket on the back of the base. Plug the other end into the telephone wall socket or approved line filter.
Only use the telephone line cord supplied or your phone may not work correctly.
Setting up is now complete. You can make and receive calls on your phone.

Your Handset

- Earpiece/Receiver**
- Display**
- Clear**
- Use to delete incorrect digits or letters
 - Press to go back to the previous menu
 - Press and hold to exit menu and return to standby.
 - Press and hold to off the snooze temporarily
 - Press to mute the conversation
- Down**
- Press during a call to decrease the earpiece volume.
 - Use to scroll through the phonebook, menu, redial list, or CALLER ID log.
 - Press to decrease the handset ringer volume when the phone rings.
- Phonebook**
- Use to access the phonebook list
- Redial/Flash**
- Press to access the redial list.
 - Press during a call for flash function
- Temporary Tone**
- Use to set up the conference call
- Microphone**



- Up**
- Press during a call to increase the earpiece volume.
 - Use to scroll through the phonebook, menu, redial list, or CALLER ID log.
 - Press to increase the handset ringer volume when the phone rings.
- Menu/OK**
- Press to access the menus.
 - Press to confirm a setting.
 - Press and hold to power on/off the handset.
 - Use with # key to switch the handset keypad lock On/Off.
- Hook**
- Press to make and receive calls.
 - Press to end calls.
- Intercom**
- Use when making internal calls, conference calls or for transferring calls (if you have more than one handset registered to your base).
- Speaker/Pause**
- Used for hands free mode.
 - Press and hold to enter a pause.
- #/Lock**
- Use after pressing menu/ok key to switch the handset keypad lock On or Off.

Your DECT1725 base and charger (+1, +2 models only)

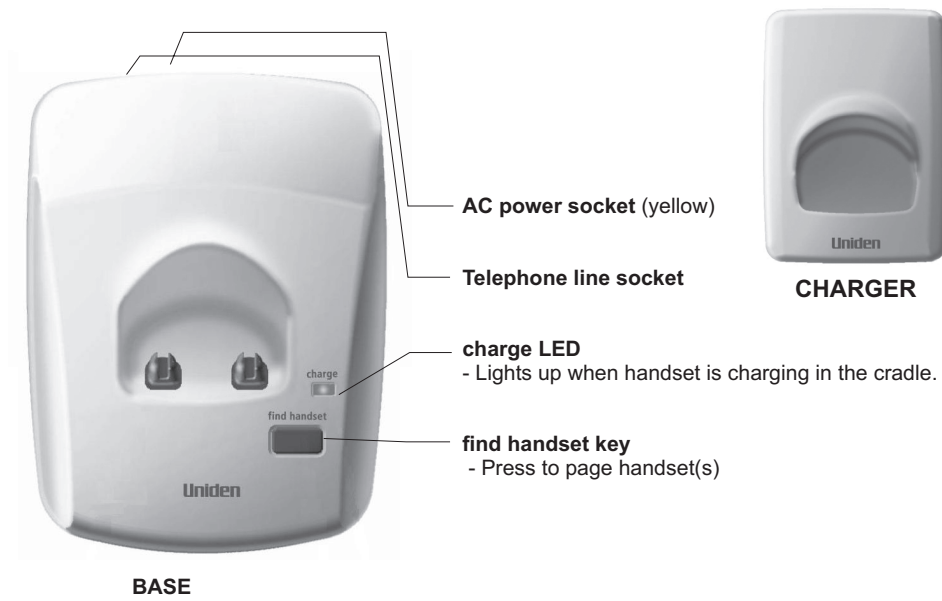



Your handset display

The following figure shows the layout of icons on your handset display.

<i>Symbol</i>	<i>Explanation</i>
	Menu
	Indicates more characters to display to the left
	Indicates more characters to display to the right
CLI	Indicates new CID
	Displayed when viewing the phonebook list or in the phonebook menu. Flashes when the phonebook is full.
	Always displayed when your handset is on, shows the battery status.
	Displayed when you have subscribed to a message waiting service and you have a new message waiting.



Symbol

Explanation

	Remains steady when the line is in use.
EXT	External call in progress
INT	Internal call in progress
	Indicates the alarm has been set.
	Always displayed when your handset is on. Flashes and you hear a warning tone during a call if the handset moves out of range, you will need to move closer to the base for clearer reception.
	Displayed when the keypad has been locked.
	Talk by speaker phone











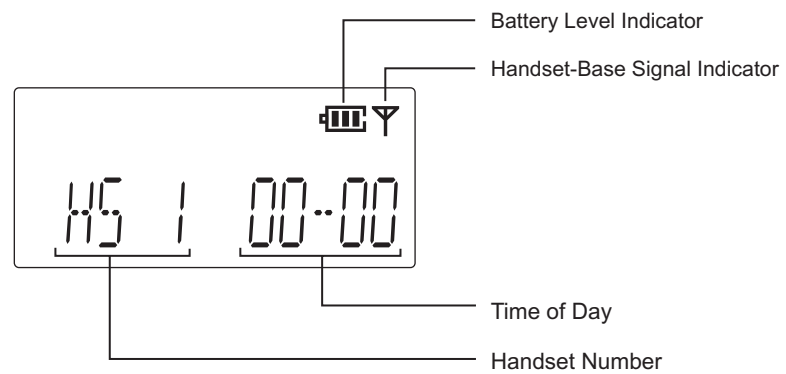

























Standby Display

Once charged, your handset display will be as below, displaying the handset name and number, and time and date. This is referred to as 'standby mode'.

For example:





Quick Guide

Function	Button press
Make a call	 or press  , enter number.
Preparatory call	Enter number,  or press  .
Adjust earpiece volume	During a call,  or  .
End a call	 or place handset on base.
Receive a call	Phone rings,  .
Redial	Press  , then  or  to display number,  or press  .
Mute	During a call,  . To resume a call press  again.
Store phonebook number	 select PHONEBOOK,  , select ADD ENTRY,  , enter name,  enter number,  . Select MELODY,  .
Dial phonebook number	 then  or  ,  or press  .
Handset ringer melody	 , select HS SETTINGS,  . Select RING SETUP,  . Select INT RING or EXT RING,  . Select MELODY  , and select a melody.
Make internal call	 , enter internal handset number.

Using your phone



Make a call

1. Press . The  symbol is displayed. When you hear the dial tone, dial the number you want. The number is shown in the display. After a short delay the call timer will start timing the call.

Adjust the earpiece/receiver volume during a call

1. Press  or  to adjust the volume. There are five levels.

Preparatory dialling (pre-dial)

1. In standby mode, enter the number to be dialed. The number is displayed. You can enter numbers up to 32 digits long. Press  to delete any incorrect digits. Press and hold  to delete all digits.
2. Press  to dial the displayed number.

Handset range

Up to 300 metres outdoors and up to 50 metres indoors (in ideal conditions).
If the handset is too far away from the base, during standby, *Searching* appears and the  symbol will flash. During a call you will hear a warning tone. You will need to move closer to the base for clearer reception and to avoid being disconnected.

Call timer

When you make or receive a call, a short while after the line is connected the call timer will show the duration of the call in the display in hours, minutes and seconds.





Handsfree mode

You can use handsfree mode to talk to your caller without holding the handset to your ear. You can speak into the handset microphone and listen over the loudspeaker.

Handsfree also enables other people in the room to listen in to the conversation.

During a call:

- 1 Press . The  symbol is displayed while in handsfree mode.
- 2 Press  again to go back to the normal talk mode.

End a call

- 1 Press .

Or

Place the handset back on the base/charger.

Receive a call

When you receive a call the handset(s) will ring (as long as handset ring volume is not set to OFF - see page 20).



The symbol **EXT** will flash in the handset display. If you have subscribed to a Caller ID service through your network supplier, the caller's number will be displayed (if available). See page 32 for further information on Caller ID.

- 1 Press  to answer the call.

Or simply lift the handset from the base (providing Auto Answer is set to On, see page 21). After a short delay the call timer will start timing the call.

Call Waiting

If you subscribe to Call Waiting and the call waiting tone sounds during a call:

Australia: Press  then 2 to switch between callers.

New Zealand: Press  to switch between callers.

Receiving internal calls

If you receive a call from another handset, the **INT** symbol and the internal caller's handset number will be displayed.







Redial

Redial the last number called













Your handset saves the last 10 numbers called into a redial list. You can select and redial any number from the list at a later time. Each handset has its own redial list. Numbers stored in the redial list can be up to 32 digits long.

Redial any of the last 10 numbers called

Your handset saves the last 10 numbers called into a redial list. You can select and redial any number from the list at a later time. Each handset has its own redial list. Numbers stored in the redial list can be up to 32 digits long.







- 1 In standby mode, press  to display the last number called.
- 2 Press  or  to display any of the last 10 numbers called.
If the name/number is stored in the phonebook, the name will be shown as well.
- 3 Press  to dial the displayed number.

Store a redial number to the phonebook

- 1 In standby mode, press  to display the last number called.
- 2 Press  or  to display the redial number you want.
- 3 Press , then use  or  to select ADD TO PB, press .
- 4 NAME? is displayed.
Enter a name using the keypad and press .
For information on entering names, see page 17.
You can enter a name of up to 12 letters.
Press  to delete an incorrect letter.
- 5 The number is displayed again, press .
- 6 Select distinctive ring. Press  or  to select a ringer press .





Deleting numbers from the redial list

- 1 In standby mode, press  to display the last number called.
- 2 Press  or  to display any of the last 10 numbers called.
- 3 With the number you want displayed, press .
- 4 Press  or  to select DELETE the number selected or DELETE ALL numbers in the list.
- 5 CONFIRM ? appears.
Press .

Mute (privacy)

When on a call you can mute the handset microphone and speak privately to someone in the same room, without your caller hearing you.

- 1 During a call, press .
CALL MUTED is displayed while mute is on and your caller cannot hear you.
- 2 Press  again to resume your call.





Finding/paging handsets

You can use the Find Handset button on the base to locate a missing handset or page the user (paging calls cannot be answered by a handset).

- 1 Press  on the base.
Any handsets registered to your base will ring.

To stop the paging ring:



- 1 Press any key on the handset or press  on the base again.
If you do not stop the paging ring, it will stop automatically after 60 seconds.





Keypad lock

The keypad lock helps prevent accidental dialling when you are carrying the handset around and can also be used to stop younger children dialling out accidentally.

Switch the keypad lock ON

- 1 Press  and then  .  symbol appears.

Switch the keypad lock OFF

- 1 Press  and then  to unlock the keypad and return to standby mode.











Using the phonebook

You can store your 50 frequently used names and numbers in the phonebook for easy dialling.

Store a phonebook name/number

Phonebook entries are stored alphabetically.

- 1 Press .
- 2 Press  or  to select PHONEBOOK.
Press .
3. Select ADD ENTRY. Press .
- 4 NAME ? appears. Enter name using the keypad, then press .
Stored names can be up to 12 letters long.
Press  to delete an incorrect letter.
To enter a space, press .

Entering names

For example, to enter the name JOHN:

For J,  press once.

For O,  press three times.

For H,  press twice.



For N,  press twice.

Press .

- 5 NUMBER ? is displayed. Enter the number.
Press .
Stored numbers can be up to 20 digits long.

Press  to delete an incorrect digit.

Press .



6. MELODY 1 is displayed. Press  or  to select a tone type and press .
The phonebook entry is now stored.

Press  to exit the phonebook menu and return to standby at any time.

Entering a 'pause' in a stored number



You may need to enter a pause in some international or charge card numbers or if you are connected to a switchboard. When storing a number, at the point where you want a pause, press and hold . A P will be shown in the display.

View and dial a phonebook entry

- 1 Press  and the first alphabetical entry is displayed.
- 2 Press  or  to scroll through the entries and display the entry you want.
Or
Search alphabetically for the entry.

To search alphabetically















Enter the first letter of the name you want using the keypad.

E.g. for HELEN, press  twice, then use  or  to display the exact entry you want.

- 3 Press  to dial the number.











Or
Press  to exit and return to standby.

Edit a phonebook name/number

- 1 Press .
- 2 Press  or  to select PHONEBOOK.
Press .
- 3 Press  or  to select CHANGE ENTRY.
Press .
- 4 Press  or  to display the name for the entry you want (or search alphabetically).
- 5 Press  to access the phonebook menu.
- 6 Press  repeatedly to delete any incorrect letters, then enter the correct letters using the keypad and press .
7. The number is displayed. Press  repeatedly to delete any incorrect digits, and enter the correct number using the keypad and press .
8. Select a melody type and press .









Delete a phonebook name/number

1. Press .
2. Press  or  to select PHONEBOOK.
Press .
3. Press  or  to select DELETE ENTRY or DELETE ALL. Press .
4. Press  or  to display the name for the entry you want (or search alphabetically).
Press .
5. CONFIRM ? is displayed. Press .

Phonebook status











This allows you to show how many entries are stored in the phonebook.

1. Press .
 2. Press  or  to select PHONEBOOK.
Press .
 3. Press  or  to select PB STATUS.
Press .
- Phonebook status is displayed.

Handset and base menu settings

Handset earpiece



There are 5 earpiece volumes to choose from.

1. Press  to access the main menu.
2. Press  or  to select HS SETTINGS and press .
3. Press  or  to select AUDIO SETUP and press .
4. Select EARPIECE V. and press .
5. Press  or  to select the volume you want, then press  to confirm.











Handset ringer volume

There are 5 ringer volumes to choose from. You can also select volume Off if you do not want to be disturbed.

You can set a different ringer volume for each handset registered to your base.













1. Press  to access the main menu.
2. Press  or  to select HS SETTINGS and

press .

3. Press  or  to select RING SETUP and press .
4. Press  or  to select INT RING or EXT RING and press .
5. Press  or  to select VOLUME and press . Select the volume you want (you will hear a sample of each as you scroll through). Press .















Handset speaker

There are 5 speaker volumes to choose from.

1. Press  to access the main menu.
2. Press  or  to select HS SETTINGS and press .
3. Press  or  to select AUDIO SETUP and press .
4. Press  or  to select SPEAKER V. and press .
5. Press  or  to select the volume you want, then press  to confirm.

Handset ringer type

There are 10 handset ringer melodies. You can select different ring tones for external calls and internal calls.











1. Press  to access the main menu.
2. Press  or  to select HS SETTINGS and press .
3. Press  or  to select RING SETUP and press .
4. Press  or  to select INT RING or EXT RING and press .
5. Press  or  to select MELODY and press . Select the melody you want (you will hear a sample of each as you scroll through), then press  to confirm.

Auto answer

Auto answer, lets you answer the phone just by picking it up from the cradle.















If you switch auto answer off, you have to press to answer a call, even if a handset is on the base.

The default setting is 'On'.

1. Press  to access the main menu.
2. Press  or  to select HS SETTINGS and press .
3. Press  or  to select AUTO ANSWER . Press .
4. Press  or  to select ON or OFF . Press .

Alarm

Your phone allows you to set an alarm.









- 1 Press  to access the main menu.
- 2 Press  or  to select HS SETTINGS.
Press .
- 3 Press  or  to select ALARM.
Press .
- 4 Press  or  to select ON or OFF.
Press .
- 5 If you select ON, enter time for the alarm using the number keypad.
- 6 Press .
- 7 Press  or  to select SNOOZE ON or SNOOZE OFF. Press .

The  appears, showing that the alarm is set to on.

When the reminder occurs, your phone will ring. To stop alarm tone, press any key on the handset. To off the snooze temporarily, press and hold .

Handset name

You can change the name your phone displays on the screen. If you have more than one handset, you can use the name to identify your handset.











- 1 Press  to access the main menu.
- 2 Press  or  to select HS SETTINGS.
Press .
- 3 Press  or  to select HS LABEL
Press .
- 4 Enter the name using the number keypad.
Press .



Language

You can change the language the menu display will use.













There are 16 languages to choose from.

- 1 Press  to access the main menu.
- 2 Press  or  to select HS SETTINGS and press .
- 3 Press  or  to select LANGUAGE . Press .
- 4 Press  or  to select language. Press  to confirm.



Base ringer volume

There are 5 volume levels to choose from or you can select volume Off.













- 1 Press  to access the main menu.
- 2 Press  or  to select BS SETTINGS and press .
- 3 Press  or  to select RING SETUP and press .
- 4 Press  or  until BS VOLUME is displayed and press .
- 5 Press  or  to select the volume you want (you will hear a sample of each as you scroll through), and press  to confirm.





Base ringer type











There are 5 base ringer melodies to choose from.

- 1 Press  to access the main menu.
- 2 Press  or  to select BS SETTINGS and press .
- 3 Press  or  to select RING SETUP and press .
- 4 Press  or  to select BS MELODY and press .
- 5 Press  or  to select the melody you want. You will hear a sample of each as you scroll through the melodies.
- 6 With the ringer melody you want displayed, press  to confirm your selection.



Call Barring

When switched on, Call Barring prevents calls being made.









- 1 Press  to access the main menu.
- 2 Press  or  to select HS SETTINGS .
Press .
- 3 Press  or  to select BARRING .
Press .
- 4 PIN ? is displayed. Enter the PIN code using the number keypad. Press .
- 5 Press  or  to select ON or OFF .
Press  to confirm.



Settings menu



Tones

You can switch on or off the tones for key touch, battery low, and out-of-range alarm. For example, when the key tone is set to ON, you will hear a tone each time you press a keypad button.

- 1 Press  to access the main menu.
- 2 Press  or  to select HS SETTINGS . Press .
- 3 Press  or  to select TONE SETUP . Press .
- 4 Press  or  to select the option you want.

KEY TONE
BATTERY LOW
RANGE ALARM

Press .











- 5 Press  or  to display either ON or OFF . Press  to confirm.

Flash

Flash is used when connected to certain switchboards, for transferring calls to another extension number, and for some network services. Contact your network or switchboard provider for advice on how to use the  button.

Changing the Flash time











You can select the flash time from short or long according to your switchboard requirements. Consult your switchboard provider for advice if unsure which setting you need.

- 1 Press  to access the main menu.
- 2 Press  or  until BS SETTINGS is displayed and press .
- 3 Press  or  to select FLASH TIME and press .
- 4 Press  or  to select SHORT or LONG and press .

Dial mode



You can set your phone to use either Tone or Pulse dialling. The pre-set setting is TONE dialling, where you will hear a tone beep each time you dial a number.

Most modern exchanges and switchboards use Tone dialling, so you should not need to change this setting. Only change it if your switchboard uses Pulse dialling or if you cannot make a call using Tone dialling.

- 1 Press  to access the main menu.
- 2 Press  or  until **SETTINGS** is displayed and press .
- 3 Press  or  to select **DIAL MODE** and press .
- 4 Press  or  to display either **TONE** or **PULSE** and press .

Tone Dialling Switch-Over (Australia only)

If you have set your phone to use Pulse dialing, you can switch temporarily to Tone dialing for the duration of a call:

- 1 Press .
- 2 Press and hold . Any digits entered after this long press of  will be dialed using tone dialing.







Registering a new handset

Registering a new handset

When you register a new handset to your base, you will be asked to enter the base PIN code. The pre-set PIN code is 0000. If you wish you can change this code, see page 29.

Each handset can only be registered to one base at a time. Before registering, make sure the new handset is fully charged and that you have the base and handset in front of you.

On the handset you want to register:

- 1 Press  to access the main menu.
- 2 Press  or  to select **REGISTRATION** and press .
- 3 Press  or  to select your base number.



On your base:

- 4 Press and hold  until you hear the registration tone. You are now in 'subscription mode'.

If the base already has the maximum number of handsets (5) registered to it you will hear the reject tone and you will need to de-register one of the existing handsets before you can register the new handset.

See section below for de-registering handsets.

On the handset you want to register:

- 5 Press .
- 6 Enter the base PIN code. Pre-set base PIN code is 0000.
- 7 Press .

You will hear a confirmation tone when registration is complete.











When in standby mode, the new handset number will be displayed.

The handset will automatically be allocated with the next available handset number.

If the registration is failed, the handset display returns to the display before enter the registration step.

De-register a handset

If you have more than one handset registered to your base you can de-register a handset registered to use.
Before registering, make sure all handsets and the base are in standby mode.











- 1 On a handset not to be de-registered, press  to access the main menu.
- 2 Press  or  until BS SETTINGS is displayed and press .
- 3 Press  or  to display TERMINATE HS and press .
- 4 PIN ? is displayed. Enter your PIN code and press .
- 5 Press  or  to display the handset you want to de-register and press .

If the handset has been registered to the base successfully, you will hear a confirmation tone.

Base PIN code











You need to enter the base PIN code when you are registering handsets. For security reasons you may wish to change the PIN code. You can choose a PIN code up to 4 digits long. If you reset the base from the handset, base PIN code will be 0000.

Always keep a record of your base PIN code. Note your PIN code and keep it in a safe place. If you change the PIN code you will need to use the new code for any handset registered to your base.

- 1 Press  to access the main menu.
- 2 Press  or  to select BS SETTINGS and press .
- 3 Press  or  to select MODIFY PIN and press .
- 4 Enter the current PIN code using the number keypad. Press .
- 5 NEW PIN appears. Enter a new PIN code and press .
- 6 CONFIRM ? appears. Enter a New PIN code again and press .

Selecting a base

You can register a handset to up to 4 bases, e.g. one at work and one at home, and switch between them. Once your handset is registered with other bases, you can either specify the base you want to use.









- 1 Press  to access the main menu.
- 2 Press  or  to select HS SETTINGS . Press .
- 3 Press  or  to select SELECT BASE . Press .
- 4 Press  or  to select the base number. Press .



Resetting your phone

If you reset your phone, both the base and handset will return to their pre-set (default) settings. If you have more than one handset registered to your base and you complete the following procedure, only the handset you reset and the base will go back to the default settings.









For the base:

- 1 Press  to access the main menu.
- 2 Press  or  to select BS SETTINGS and press .
- 3 Press  or  to select BS DEFAULT and press .
- 4 PIN ? appears. Enter your PIN code.
Press .

The base will reset and the handset will return to standby mode.



For the handset:

- 1 Press  to access the main menu.
- 2 Press  or  to select HS SETTINGS and press .
- 3 Press  or  to select HS DEFAULT and press .
- 4 PIN ? appears. Enter your PIN code.
Press .

The handset will reset and the handset will beep.





Default settings

Handset and base

Ringer Volume	Base	Level 4	Alarm	Off
	Handset	Level 5	Auto Talk	On
Ringer Type	External	Melody 1	Language	English
	Internal	Melody 1	Select Base	Base1
Tone	Key	On	Flash Time	Short(Australia) Long (New Zealand)
	Battery Low	On	Base PIN	0000
	Range Alarm	On	Call Barring	Off





Network services

TO USE CALLER ID OR ANY OTHER SERVICES DETAILED IN THIS SECTION, YOU MUST FIRST CONTACT YOUR NETWORK PROVIDER AND SUBSCRIBE TO THE RELEVANT SERVICE.

Caller ID

With CALLER ID the caller's number is shown in the handset display as you receive an incoming call so you can see who is calling before you pick up the phone.

Only the last 12 digits of the number are displayed. If the number has more than 12 digits you will see the symbol ► below the first digit.

If your caller's number is stored in the phonebook and an exact number match is found, the caller's name will be displayed instead of the number.

Only the first 12 letters of the caller's name are displayed.



Calls log

To view the Calls log, press  when the phone is in standby mode, and use  or  to scroll.

The calls log stores details of the last 40 incoming calls.





It can store numbers up to 20 digits long and names up to 12 characters long. When you have new calls the number of message appears in the display.

If the caller has withheld their number, WITHHELD NUM will be displayed or, if the number is unavailable the display will show UNAVAILABLE. You will not be able to dial back an entry with one of these messages.

When the calls log is full, a new call will replace the oldest call.







View the Calls log

- 1 Press  .
The latest calls log entry is displayed (or EMPTY if there are no entries).
- 2 Press  or  to scroll through the calls log.
- 3 Press  or  to continue viewing other calls log entries.







Or



Press  to exit and return to standby.





Dial calls log number

- 1 Press  . The latest calls log entry is displayed.
- 2 Press  or  to scroll to the number you want.
- 3 Press  to dial the entry displayed.

Copy Calls log number to the phonebook











- 1 Press  to access the main menu.
- 2 Press  or  to select CID BOOK and press  . The latest calls log entry is displayed.
- 3 Press  or  to scroll and display the entry you want.
- 4 Press  to dial the entry displayed.

- 5 ADD TO PB is displayed. Press  .
Enter a name using the keypad and press  to confirm.
If you enter a name that is already stored in the phonebook, you will be prompted to enter another name.
- 6 The number is displayed.
If necessary you can edit the number, using  to delete any incorrect digits and entering new ones using the keypad. The cursor appears at the first digit. For Telecom customers you can enter a 0 at the start to complete the STD prefix.

To confirm and save the entry to the phonebook, press  .
- 7 Press  or  to select a distinctive ring.
Press  .
- 8 Press  to exit and return to standby.



Delete Calls log entry(ies)

- 1 Press  to access the main menu.
- 2 Press  or  to select CID BOOK and press . The latest calls log entry is displayed.
- 3 Press  or  to scroll to the entry you want. If you delete all calls log, skip this step.
- 4 Press .
Select DELETE or DELETE ALL.
Press  CONFIRM ? appears. Press  to confirm.
- 5 Press  to exit and return to standby.



Using extra handsets

If you purchased a multi-pack all your handsets come pre-registered to the base.

Your phone is GAP compatible, which means you can register other DECT (Digitally enhanced cordless telephone) GAP compatible handsets to your base and register your handset to other GAP compatible bases.

You can use a total of 5 handsets with your base. Your handset can only be used with one base at any time.

To register a handset to your base, see page 27.

To de-register a handset from your base, see page 28.

If you already have 5 handsets registered to your base and you want to register a new handset, you will first need to de-register one of your existing handsets, see 'De-registering a handset', page 28.

With more than one handset you can make internal calls, transfer calls and hold conference calls.



Register your handset to another base

Follow the procedure for registering shown in the other manufacturer's user guide.

Call another handset (internal call)

- 1 Press . The symbol and **INT** are displayed and you will hear the internal call dialing tone.
- 2 Enter the number of the handset you want to call using the number keypad.

Answer an external call while on an internal call

During an internal call, if an external caller is trying to get through, you will hear a series of short beeps to alert you to the call.

If you have Caller ID, the caller's information will also be displayed.

- 1 To end the internal call, press to take the external call.







Transferring a call

You can transfer an external caller from your handset to another internal handset.

During an external call:

- 1 Press . The external caller is put 'on-hold'.
- 2 Enter the number of the handset you want to call using the number keypad.
- 3 When the called handset answers, press  or place the handset back on the base to transfer the call.



If the called handset does not answer, press  to return to the external caller.



Conference call

You can hold a 3-way conversation (conference call) between your handset, an external caller and another internal handset user.

During an external call:

- 1 Press . The external caller is put 'on-hold'.
- 2 Enter the number of the handset you want to have a conference call with. The called handset will ring.
- 3 When the called handset answers, press  on the initiating handset to start your conference call.
- 4 Any handset can press  at any time to leave the conference call.





Simple solutions

The most common problems often have the simplest solutions.

We hope that you will not experience any problems with your product, but in the event that you do, this section hopes to overcome any problems quickly and with minimum effort.

Firstly, check that:

- the telephone line cord is correctly connected.
- the mains power cord is correctly connected and switched on.
- the battery pack is charged and not in need of replacing.

If you have more than one handset registered to your base remember to check the connections on this too.

If you are still experiencing a problem, you are likely to find a solution opposite.

- If your phone line also has High Speed Internet please ensure you are using an approved line filter (check with your High Speed Internet provider if unsure about the filters).



Handset/Base

No dial tone

- Is the handset registered to the base?, see page 27.
- Is the  symbol flashing and can you hear a beep during a call? – if so, move closer to the base as you are out of range.

Cannot dial out

- Is  symbol displayed, if so the keypad lock is on, see page 16.

Handset does not ring

- The ringer volume may be set to off, see page 20.
- Is the  symbol flashing? – if so, move closer to the base as you are out of range.



**Handset is not charging properly**

- Check that the charge light is on and that the handset is sitting correctly in the base or charger. Clean the charging contacts with a dry cloth.
- Are you using the power adaptor supplied with your phone?

Handset will not link up with the base

- Is the  symbol flashing? – if so, move closer to the base as you are out of range.
- Is the handset registered to the base, see page 27.
- Buzzing noise on my radio, TV, computer or hearing aid Sometimes your phone may interfere with other electrical equipment if it is placed too close. We recommend you leave a distance of at least one metre to avoid this.

**Cannot make a call**

- Is the Call Barring set, see page 25.

CALLER ID**Caller's details are not displayed**

- Have you subscribed to a CALLER ID service? If not, contact your network provider.
- The caller may have withheld their details.
- Let the phone ring a couple of times as there may be a delay in receiving the CALLER ID information.

Caller's name is not displayed even though it is stored in the phonebook

- The name will only be displayed if an exact number match is found. Make sure that the number in the phonebook is a match with the received number in the Caller ID log.





General information

This equipment is not designed for making emergency telephone calls when the power fails. Alternative arrangements should be made for access to emergency services.



Safety

- Only use the power supply that came with the product. Using an unauthorised power supply will invalidate your guarantee and may damage the telephone.
- Do not open or tamper with the handset or base (other than to change the batteries). You could expose yourself to high voltages or other risks.

Please see warranty page for contact information regarding repair. Or visit our website at www.uniden.com.au, www.uniden.co.nz.
- Radio signals transmitted between the handset and base may cause interference to hearing aids.
- DO NOT use your phone:
 - near emergency/intensive care medical equipment.
 - if you have a pacemaker fitted.
 - during an electrical storm.





- DO NOT position your product:
 - less than one metre away from other electrical appliances, e.g. TV and radio sets, clock/alarms and computers, or you risk interference.
 - on antique/veneered wood (as the product may become warm during charging).
 - on carpets or other surfaces which generate fibres.

Always ensure free flow of air over the products surfaces.

- DO NOT expose your product:
 - to water (or use it in damp conditions, such as in bathrooms).
 - to fire, explosive or other hazardous conditions.
 - to direct sunlight.
- DO NOT dispose batteries with ordinary domestic refuse. There is a risk of the release of highly toxic chemicals.



Maintenance

Cleaning your product:

Wipe the handset, base and charger with a damp (not wet) cloth, or an anti-static wipe. Never use a dry cloth as this may cause a static shock. Never use household polish as this will damage the product.

Replacing the handset batteries:

Over time, as the handset batteries wear out, the talk and standby times after charging will reduce. The batteries will eventually need replacing.

Inserting new batteries:

- 1 Remove the battery compartment cover and the old batteries.
- 2 Insert rechargeable batteries. Connect the batteries with the correct polarity. Replace the battery compartment cover.





How many telephones can I have?

All items of telephone equipment have a Ringer Equivalence Number (REN), which is used to calculate the number of items which may be connected to any one telephone line.

The total recommended REN on one line is 3. If you exceed a REN of 3, your phones may not ring. With different telephone types there is no guarantee of ringing, even when the REN is less than 3. Your phone has a REN of < 0.01 (even with additional handsets and chargers registered to your base).





One Year Limited Warranty

Important: Evidence of original purchase is required for warranty service.

Warrantor: Uniden Australia Pty Limited A.B.N. 58 001 865 498 Uniden New Zealand Limited

ELEMENT OF WARRANTY: Uniden warrants to the original retail owner for the duration of this warranty, its DECT1725/DECT1725+1/DECT1725+2 (herein after referred to as the Product), to be free from defects in materials and craftsmanship with only the limitations or exclusions set out below. **Warranty is only valid in the original country of purchase.**

WARRANTY DURATION: This warranty to the original retail owner only, shall terminate and be of no further effect 12 months after the date of original retail sale. This warranty will be deemed invalid if the product is;

- (A) Damaged or not maintained as reasonable and necessary,
- (B) Modified, altered or used as part of any conversion kits, subassemblies, or any configurations not sold by Uniden,
- (C) Improperly installed,
- (D) Repaired by someone other than an authorized Uniden Repair Agent for a defect or malfunction covered by this warranty,
- (E) Used in conjunction with any equipment or parts or as part of a system not manufactured by Uniden.

PARTS COVERED: This warranty covers for one (1) year, the Base unit, charger and handsets. All accessories (AC adaptor etc) are covered for 90 days only.

STATEMENT OF REMEDY: In the event that the product does not conform to this warranty at any time while this warranty is in effect, the warrantor at its discretion, will repair the defect or replace the product and return it to you without charge for parts or service. THIS WARRANTY DOES NOT COVER OR PROVIDE FOR THE REIMBURSEMENT OR PAYMENT OF INCIDENTAL OR CONSEQUENTIAL DAMAGES. THIS GUARANTEE IS IN ADDITION TO AND DOES NOT IN ANY WAY AFFECT YOUR RIGHTS UNDER THE CONSUMER GUARANTEE ACT.

PROCEDURE FOR OBTAINING PERFORMANCE OR WARRANTY: In the event that the product does not conform to this warranty, the Product should be shipped or delivered, freight pre-paid, with evidence of original purchase (eg. a copy of the sales docket), to the warrantor at:

UNIDEN AUSTRALIA PTY LIMITED SERVICE DIVISION

345 Princes Highway,
Rockdale,
NSW 2216,
AUSTRALIA
Fax: (02) 9599 3278
www.uniden.com.au

UNIDEN NEW ZEALAND LIMITED SERVICE DIVISION

150 Harris Road,
East Tamaki,
Auckland,
NEW ZEALAND
Fax: (09) 274 4253
www.uniden.co.nz

THANK YOU FOR BUYING A UNIDEN PRODUCT.

Uniden®

(c) 2006 Uniden Australia Pty Limited. Uniden New Zealand Ltd. Printed in China UCZZ01882WZ(0)